



ARDENT
HIRE SOLUTIONS



ROTO TECHNICAL GUIDE

roto@ardenthire.com www.ardenthire.com



CONTENTS

Ardent's game changing service is built on 3 core components which form our promise to each and every customer.

The components



INCREASING PRODUCTIVITY

Helping our customers increase productivity of machines on their sites through detailed management and technology



REDUCING COST

Actively engaging with customers to help reduce operating costs through technological advancements.



REDUCING RISK

Working with our customers to offer industry leading service and products to minimise risk on site

What Makes Ardent

- 4 Our Service
- 6 Accreditations
- 8 Ready for rent
- 10 Innovation
- 24 Roto Telehandlers
- 40 Key Benefits
- 42 Attachments
- 44 Coverage

Key Contact

For New & Existing Hires

- ☎ 03333 202 555 (opt.1)
- ✉ roto@ardenthire.com



OUR SERVICE

We believe in challenging the status quo of the hire industry in everything we do. We believe in thinking differently.



The way we challenge this status quo is by helping customers improve their productivity, reduce operating costs and reduce risks in their businesses. And to top it all, Ardent offers the most reliable, highly specified and youngest fleet in the industry today. This provides customers with unbeatable value and superior performance.

- New machinery with an average age of less than 2 years
- Fully compliant tier 4i/4 final fleet
- Over 99.5% uptime
- National coverage
- Industry leading technology
- Fully comprehensive selection of attachments to increase utilisation
- Specialist supplier
- Flexible delivery system with over 54 delivery vehicles
- Over 56 in-house fitters and access to over 650 manufacturers' engineers
- Target service response time of 2-3 hours
- Largest buyer of industry leading products



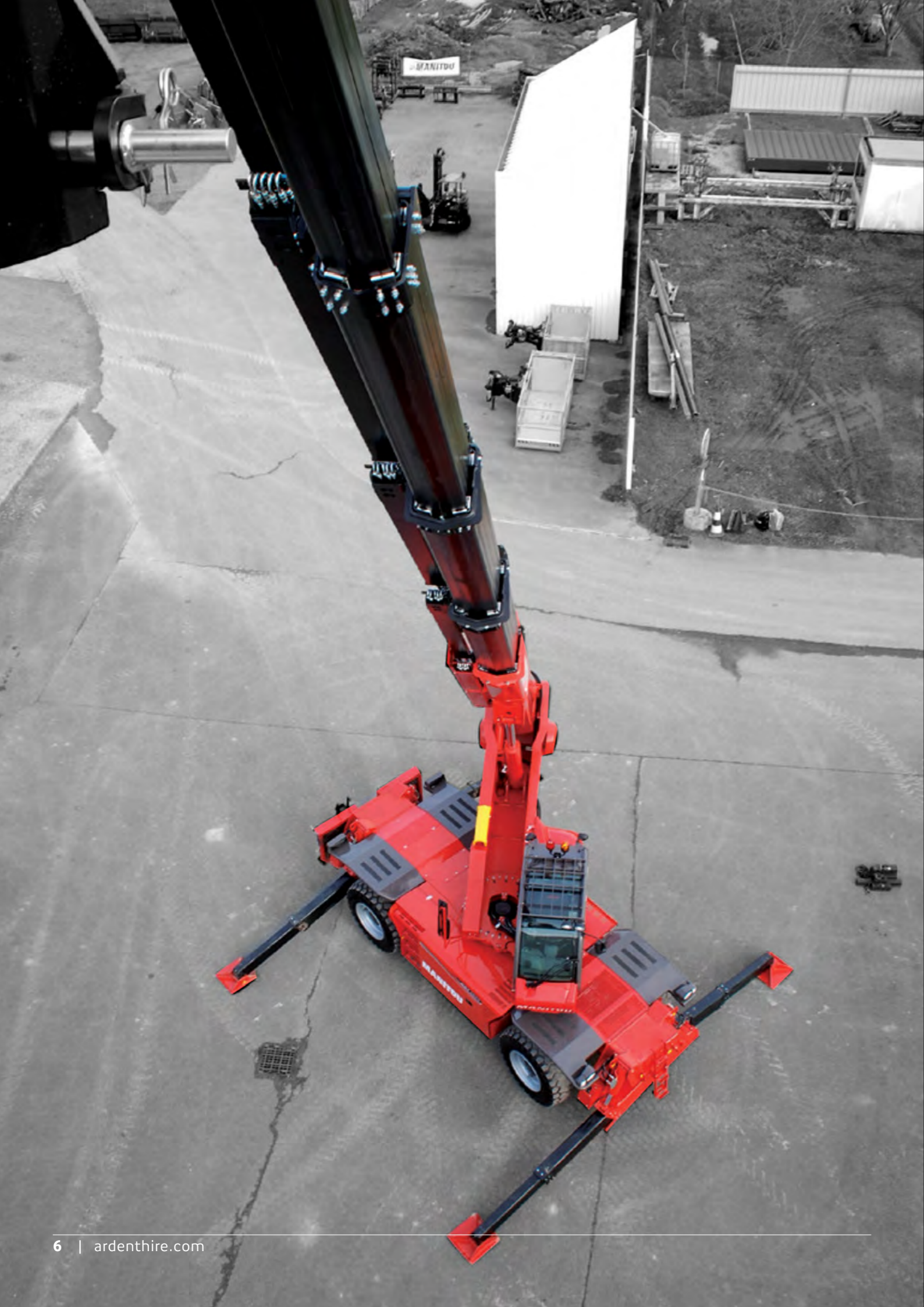

ACCREDITATIONS AND AWARDS

The last few years have been a fantastic for Ardent Hire Solutions Ltd in the digital world. We have invested more in technological development in the last two years than we have in all previous years combined. Our teams have accomplished so much and pushed the limits on innovative thinking. They have made ideas reality and set a new bar for our industry to work towards. In 2021 we were finalists in 19 award categories across 7 awarding bodies. Our Digital Platform attracted over 5,000 users with an 84% increase over the last 12 months.



READY 4 RENT



At Ardent we aren't a business that wants to work to an industry standard, we are constantly looking to raise the bar and we are committed to delivering improved productivity, a reduction in the total cost of operating your plant and a reduction in risk that operating plant brings to your business.

Ready 4 Rent is a key part of delivering on those three commitments. The difference between something good and something great is attention to detail and that is what R4R is all about. R4R is focused on reliability and quality, the machines go through a rigorous pre-hire process to make sure the quality of the machine is the best it can be and once it has been through the R4R process our engineer will put a

R4R tag in the machine which will be signed by both the engineer and their line manager to confirm it has reach the set standard for that machine type, our people take pride in their work and are committed to exceeding your expectations.

We already buy the best machines on the market, JCB and Manitou for telehandlers, Hitachi, Kubota and Komatsu for excavators, Thwaites for dumpers and Ammann for rollers. R4R is designed to enhance the machine offering by making sure that no matter which Ardent depot you are hiring from, you will get a market leading machine that has been prepared to our consistent exacting standards.

Just a few things that set us apart:

- The Ardent Picking List will be used to confirm the order requirements and specification.
- The machine will be thoroughly valeted inside and out, including the glass and tyres being shined, all mud removed from tracks, seat covers and floor mats will be in position in the operator cab. Damaged stickers will be removed and replaced and cosmetic damaged repaired and repainted.
- We will check to see if machine requires a service within the next **100hrs**. If the machine requires a service this will be done. **We will not send out a machine to a customer that is close to the next service interval, we don't want you to experience unnecessary downtime.**
- We will check to see if the Thorough Examination on the machines expires within the next 90 days, if it does this will be carried out prior to despatch to the customer. **We will not send out a machine to a customer where the thorough examination is about to expire, we don't want you to experience unnecessary downtime.**
- The machine will have a thorough pre-delivery inspection (PDI), including all relevant grease points greased and booms wax oiled. The PDI paper work will be filled in, signed and dated correctly and a copy of this will be left in the plastic wallet placed inside the cab.
- A copy of the most up to date Thorough Examination certificate will be placed inside the plastic wallet.
- All fluid levels including fuel, windscreen washer fluid and AdBlue tanks will be filled to the maximum level.
- All attachments will be tried and tested on the machines including buckets. Hydraulic couplings will also be checked and work correctly with no leaks.
- Excavator buckets and hitches will be painted as per company policy and be clean and in good order.



INNOVATION

Completely transparent delivery and collection process



Ardent has rolled out a new electronic delivery system for all delivery drivers. Each driver has been issued with a tablet computer which uses the mobile network to accurately capture information. This includes time, date, GPS, signature and images.

By converting to an electronic delivery system, we are able to save approximately 60,000 sheets of A4 paper per year, as well as significantly streamlining the back-office administration process.

Key benefits

- ✓ Data is clearly captured and presented
- ✓ Reduces the amount of administration required
- ✓ Real time functionality making it completely transparent
- ✓ Easy and simple to use and no extra cost to our customers
- ✓ Images, time and GPS stamps can be taken on site minimising queries

ARDENT TV

Ardent TV is an exciting new medium for sharing informative, educational and ground-breaking information with customers to help them improve the value they get from their hires.

For example, we now use Ardent TV to promote toolbox talks to educate operators and instil best practices, ensuring everything is being done in a safe, efficient and sustainable way.

We are offering customers industry-first videos which provides them with a thorough and detailed step-by-step guide to machine operations, maintenance and safety. We have also worked on a series of shorter site support videos structured as 'how to' videos, to help customers overcome common issues themselves. This will not only reduce the number of service calls to our hire and service desks but will also help customers save time and money.

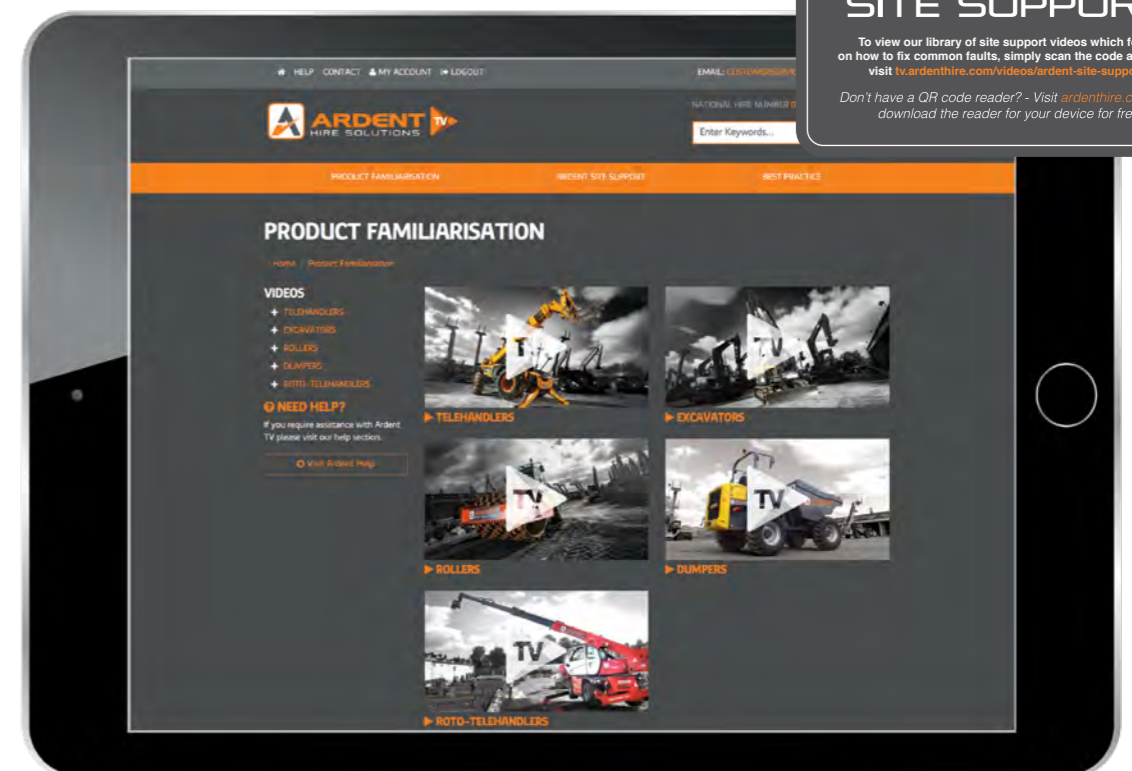

TRACKING AND DELIVERY

We now offer a real-time delivery and collection app which allows you to track your deliveries and collections to site and be updated every step of the way. As soon as your delivery or collection driver is en route, you will be sent a text message with a link, which once clicked, will take you to our app allowing you to track your order in real time.

The mobile app displays precise location of our vehicles real-time.

You will also be alerted when your driver has arrived to site. Our tracking app will display the real-time location of your vehicle on a digital map. The location of our vehicle is updated every few seconds to our servers, using this data, the mobile app displays precise location of our vehicles real-time.

You can swipe for easily accessing information about your vehicle and driver. What's more, you can send the tracker to someone else to track on your behalf. Once your machine has arrived or been collected, you can rate our driver and offer any helpful feedback to allow us to improve our service.

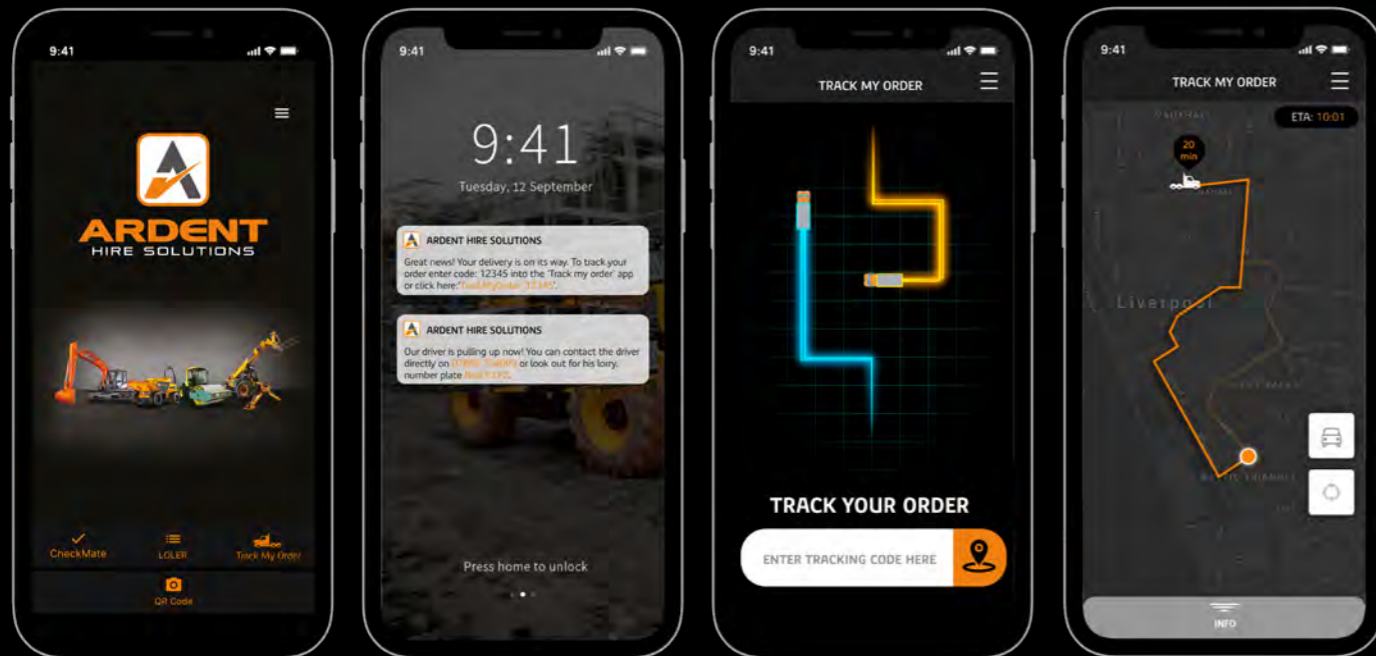

ARDENT INSIGHT



Ardent is pleased to announce the launch of the latest version of its online portal, Ardent InSite, that enables customers to manage every aspect of their hires online.

Developed inhouse over the last 18 months, Ardent InSite provides a complete digital experience for customers and enables them to manage their hires efficiently and without fuss.

As well as being able to place orders and offhire equipment online, customers can view invoices, paid and outstanding, along with all the relevant backing information. Customers can also see all their machines and attachments on hire by site and produce live hire reports. The status of service calls can be tracked along with ETAs for engineers and repair times and calls can be escalated where issues need fixing more quickly. Customers can also download LOLER certificates and monitor expiry dates so that renewals are completed on-time, ensuring compliance with regulations.

New features include allowing customers to download their carbon offset certificates for those that have elected to make their hires carbon neutral. Customers can also track who has been familiarised in Ardent's equipment and print copies of familiarisation certificates, thus improving compliance and reducing risk.

Ardent InSite includes a permissions editor enabling customers to add or delete users with different levels of access to the system.

The platform is seamlessly integrated with Ardent's multi award winning telematics information system, Site Manager, and Ardent TV, which provides comprehensive familiarisation videos and testing, including Site Support which enables operators to remedy simple issues themselves without the need for a fitter and unnecessary downtime.



ARDENT APP

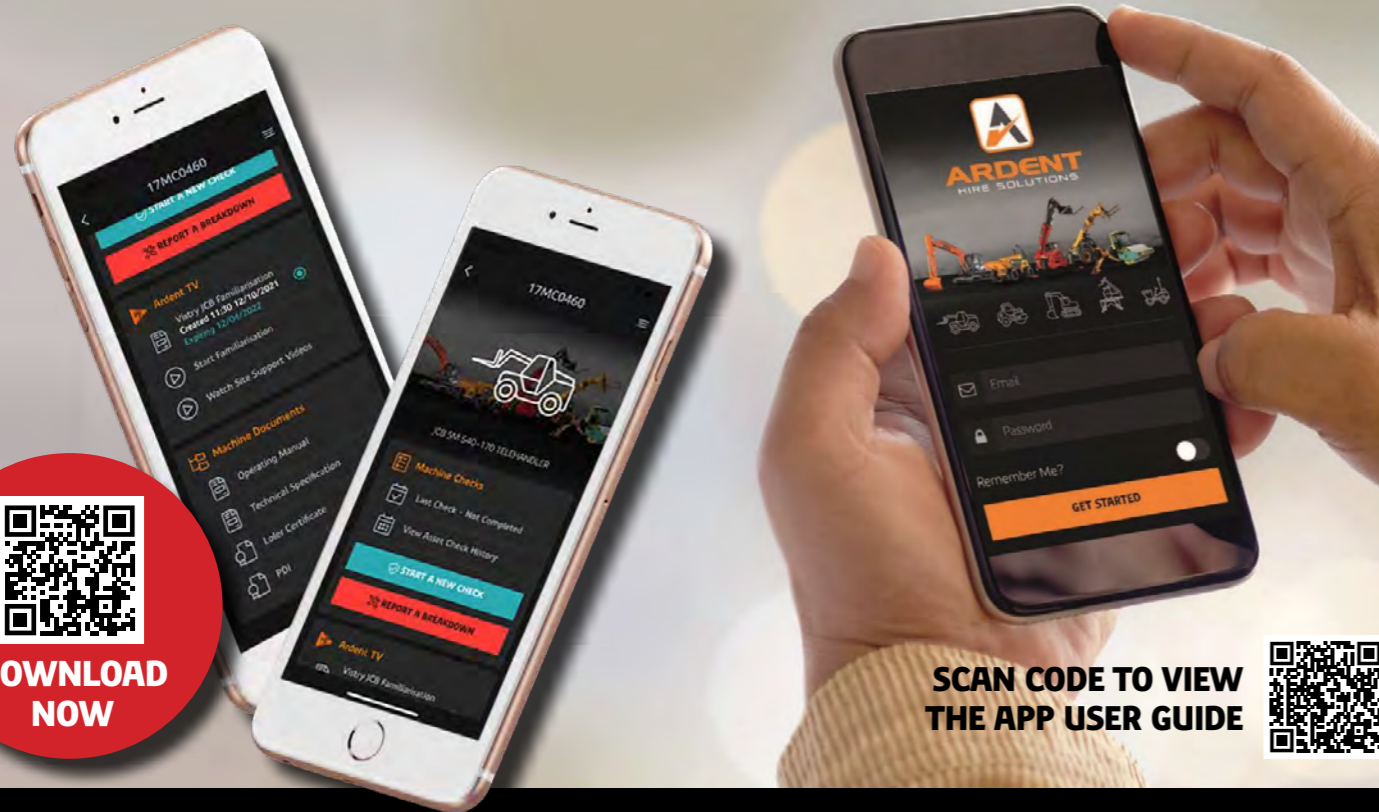

DOWNLOAD NOW

SCAN CODE TO VIEW THE APP USER GUIDE



The Ardent App offers several digital services that are integrated with Site Manager to improve on-site safety and help customers pinpoint trouble areas. The app is easy to download and has a simple registration process that requires no back-office support.

Once downloaded, the operator can enter the machine fleet number and gain instant access to machine familiarisations, site support videos, machine documentation including lifting charts, operator manuals, LOLERs and PDIs.

Customers can load their own daily checks into the admin portal allowing them to track daily machine safety checks and notify management where these are not being done. Users can report defects and prioritise health and safety repairs. The app also provides a real-time delivery tracking feature so that users know the exact status of deliveries and collections and ETAs.

Finally, users can upload company specific documents into the app which need reviewing or

signing by operators before access to the rest of the app's functionality is allowed.

The app eliminates paperwork, improves processing speeds and reduces back-office overheads which helps create a safe and efficient working environment. All data captured on the app is permanently stored and accessible in real time within Ardent InSite.

"Ardent's app has transformed the way we complete daily checks on site. We get notified when machines are being used without daily checks being completed which is incredible."

Category Manager, EKFB

COMPLETE DAILY CHECKS

Operators can run through customised daily checks on each piece of equipment quickly and easily using the app, while managers can monitor compliance:

- Daily checks can be customised to your company criteria including supporting documents/text instructions/videos to instruct the operator how to correctly complete the check.
- App logs full check details and check history, including who completed the check.
- Site Managers can receive a text when a machine is being used without a daily check being completed.
- Checks can be classified as H&S specific and non H&S specific with distribution channels to ensure the right people are notified.

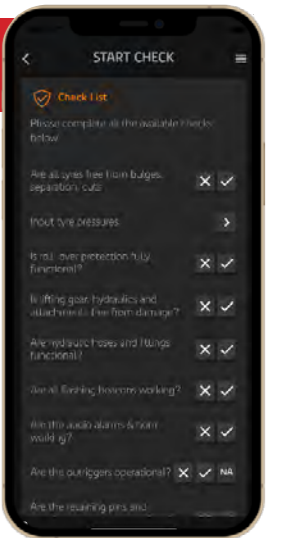

REPORT BREAKDOWNS

Customers can report breakdowns directly via the app, with in app assistance for common, fixable faults. With the app:

- Operators can take pictures and add notes to help with fault diagnosis
- Customers can also classify breakdowns as H&S specific and non H&S specific with distribution channels, so the right people are notified.
- All breakdowns can be analysed and reviewed through the management portal and customers can analyse breakdowns by operator/machine/site etc.

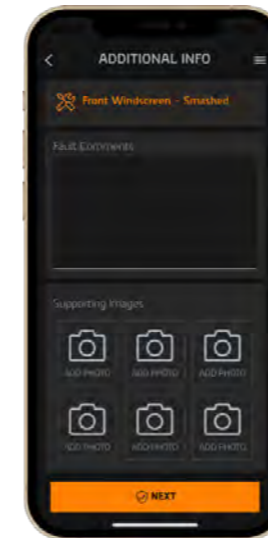

ACCESS FAMILIARISATIONS AND SITE SUPPORT VIDEOS

Operators can access familiarisations and certificates quickly and easily, along with a range of site support services, including:

- Site support videos relating to their machine.
- Short self help videos to address any common problems such as water in fuel, handbrakes adjustment, lock out procedure, start up checks and steering rephrasing.
- Problems can often be fixed without waiting for an Ardent engineer, saving downtime, and increasing productivity.

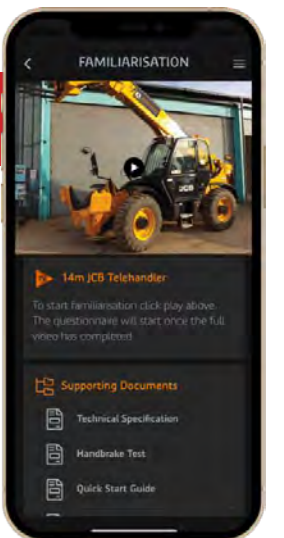

ACCESS MACHINE DOCUMENTATION

Operators and site managers will have full access to machine documentation, including:

- LOLERs
- PDI documents
- Operator handbooks
- Lifting charts
- Technical specifications
- Customers can also upload their own documents

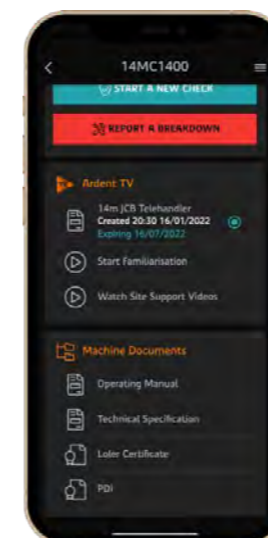

SITE MANAGER

Busy construction sites are homes to dozens of hired-in plant, often from different providers. It can be hard to keep a track of machines and their usage. Ardent's digital approach does this and notifies users when utilisation drops below a certain threshold, prompting managers to off-hire equipment when it is no longer needed and save cost.

Ardent's Site Manager platform provides a 'rear-view window' of events happening onsite by using the telematics data feed emitted from Ardent's entire fleet. Site Manager interprets and presents the data in an easy-to-understand report-style live portal. With this indisputable management information, customers gain significantly enhanced control and oversight for operational, production and safety teams across their organisation, plus information on their fleet to specifically:

- Improve site safety and equipment productivity;
- Reduce equipment downtime, operating costs, carbon footprint.

Ardent's Site Manager Alerts channels telematics data to notify users of impending equipment damage before it occurs, enabling them to take steps and save cost. Similarly, Ardent notifies managers when safety rules are breached, allowing them to act and prevent injury and loss of life.

The Ardent Digital Platform (ADP) creates certainty from uncertainty. It provides facts and data that allow site managers to improve site planning, reduce costs and ensure adherence to project schedules. It puts telematics information into the palm of the hands of those that need it to manage their sites more effectively. It creates urgency on sites to address unsafe behaviour. And it provides transparency on an unprecedented scale that is transforming not just the hire industry but the way that customers are managing plant on their sites.



REDUCE RISK



INCREASE PRODUCTIVITY



REDUCE COSTS



"We revolutionised the way telematics data is used in the rental industry."

Jeremy Fish, CEO

OUR CARBON STRATEGY

Our carbon strategy has four elements:

1 Reducing

Emissions using our multi-award winning proprietary platform, Site Manager, which helps users to minimise idling, excessive fuel use and emissions. Our experience is that customers reduce idling from an average of around 18% to less than 5% using this approach. As well as reducing emissions customers also reduce their fuel costs.

2 Offsetting

The balance using Ardent's award winning not-for-profit carbon offsetting service in conjunction with leading carbon developer and B-Corp, Climate Care. The process is open and transparent with full details and costs published on Ardent's website. For the past 2 years Ardent has also purchased carbon credits to offset the emissions from its entire HGV fleet meaning that all customer deliveries and collections are completely carbon neutral.

3 Investing

In the latest fleet which has the most recent, up to date technologies that are at the leading edge of emissions standards and are fuel efficient at the same time. In the last 4 years Ardent has spent over £250m on new fleet resulting in the company having one of the most modern and up to date fleets in the UK today.

4 Innovating

By trialling new technologies including electric machines and alternative fuels such as HVO. Our view is that the prohibitively high capital and rental costs of this equipment are likely to be a disincentive to many customers. Hydrogen is likely to be a more practical solution although the technology is still in its infancy. Ardent is also trialling alternative fuels such as HVO, however, customers should be aware that while these reduce particulate tail-pipe emissions they do not offer tail-pipe greenhouse gas reductions which are instead delivered in the overall well-to-wheel supply chain. Well-to-wheel means that all direct and indirect emissions resulting from a fuel's supply chain are considered, rather than simply measuring tail-pipe output.

ALL ROTOS are hired Carbon Neutral as we have already off set their Carbon.

Reducing

Using Site Manager. Typically users reduce fuel idling by 10% with this approach.

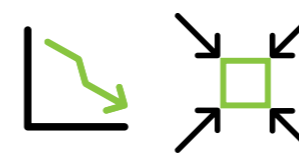

1

Offsetting

With our Award Winning Carbon Offsetting Programme. NB: All deliveries & collections are carbon neutral courtesy of Ardent Hire.



2



Innovation

Electric fleet and alternative fuels. HVO available now.



4



Investing

In stage V equipment and a modern fleet that complies with the latest environmental emission standard. Over £250m invested in the last 4 years.

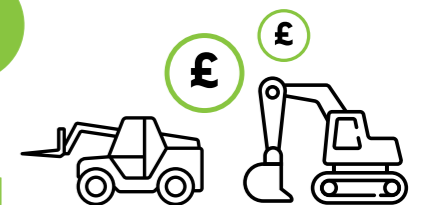

3

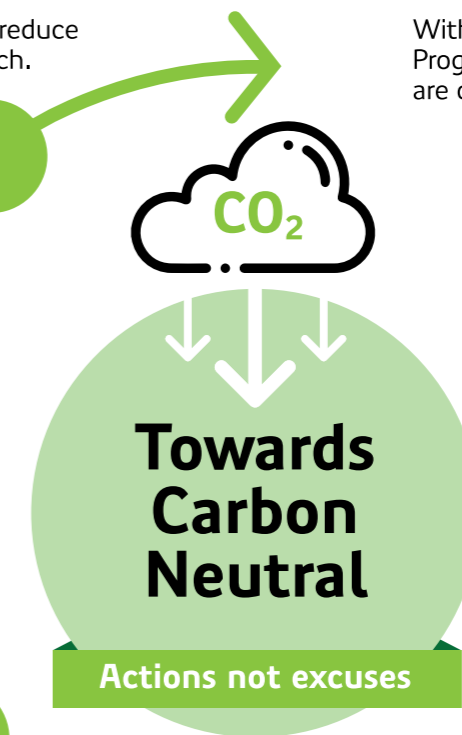

GROWTH THROUGH EXCELLENCE

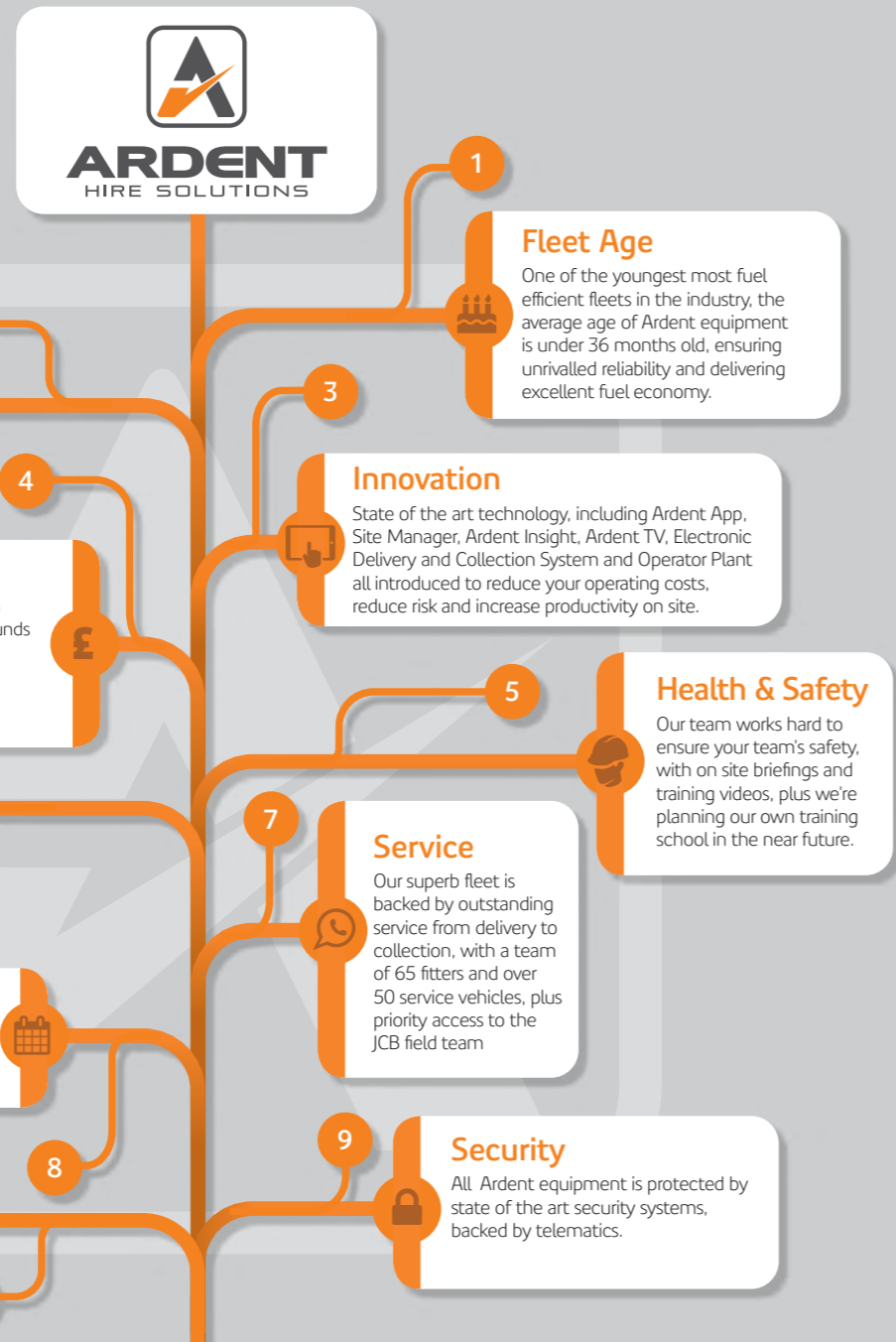

INCREASING PRODUCTIVITY

Helping our customers increase productivity of machines on their sites through detailed management and technology

REDUCING COSTS

Actively engaging with customers to help reduce operating costs through technological advancements.

REDUCING RISK

Working with our customers to offer industry leading service and products to minimise risk on site

SECURITY

Higher security, bigger savings

Security is a big issue for us, because we know it's a big issue for you. Each year in the UK, approximately £90 million worth of hire equipment is stolen, and only a mere 5% is recovered. That's a lot of firms with higher insurance premiums, greater disruption and more downtime.

Each quarter, we work with manufacturers developing new and improved security features. It means our machinery and equipment is among the most secure in the business. Therefore, our customers make fewer insurance claims.

Being at the forefront of industry security means we've been able to develop a two-pronged attack towards criminals: prevention and reaction.

We install immobilisers on all our new vehicles. These prevent unauthorised use and loss of machinery and equipment.

This in turn means you've less downtime, fewer expensive and lengthy insurance claims and no replacement costs. If we're organised, so are criminals. Thefts can happen and when they do, it's how we react that's important.

We install trackers on all new assets coming onto our fleet which can be activated upon request. We can also fit trackers to any other machinery on our existing fleet. This gives us, and the Police, the ability to locate stolen equipment with pinpoint accuracy over the Internet, 24/7.

In short, working with us, you're secure.

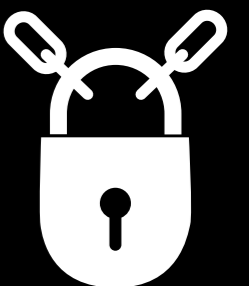

21M ROTO 5T MRT2150



Aircon



Road Legal



Beacons



Chassis Leveling



Adaptive Load Chart



Hose Burst Check Valves



Belly Plate



Bluetooth remote control



E-reco attachment recognition



QR Code Enabled



Slew/Height restrictors



Ardent Insite/site manager



Carbon Offsetting



360 Camera



Reversing Camera



OKO Compatibility

Weight:	16,095 kg
Length:	6,780 mm
Width:	2,430 mm
Height:	3,050 mm
Max Lifting Height:	20,600 mm
Max Lifting Weight:	5,000 kg
Counter Weight Offset:	2.68 m



Width: 5.55m
Length: 5.19m

Rotation on lowered stabilizers
with forks

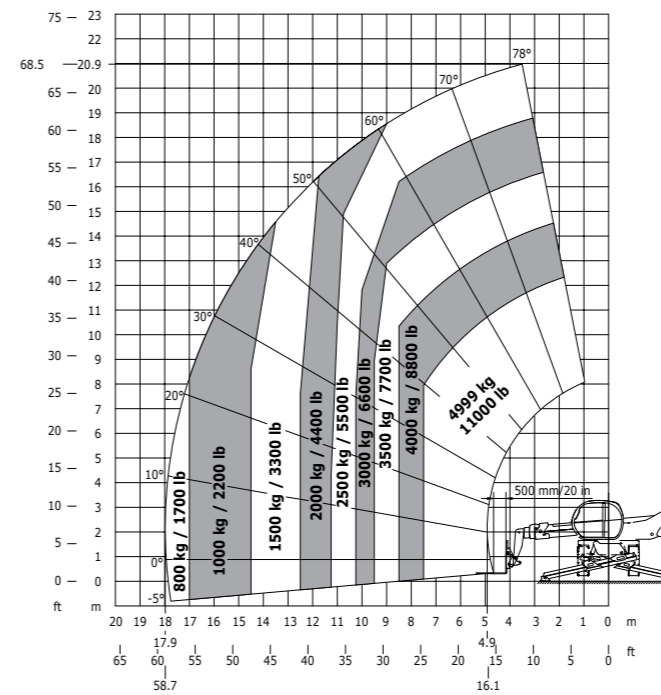

Rotation on lowered stabilizers
with 5000 kg winch

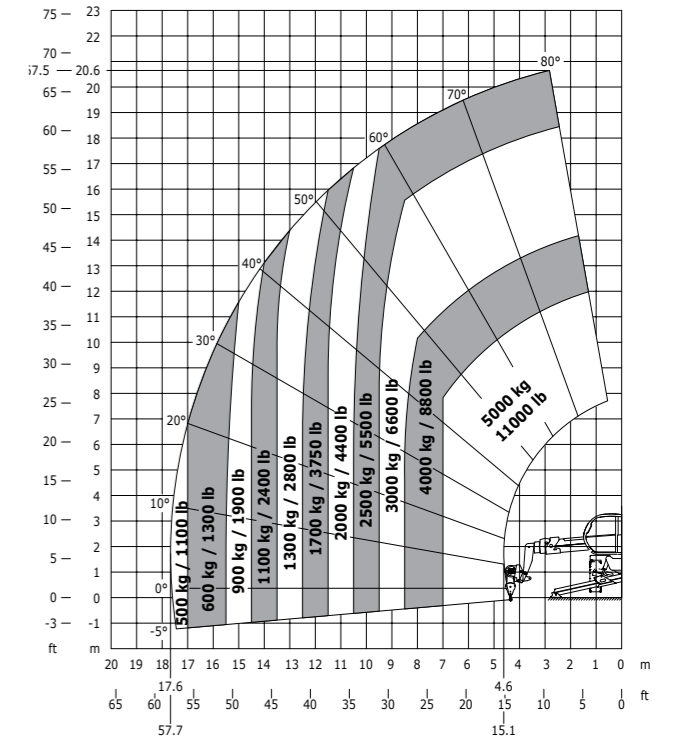

PT2000 Jib Winch Load chart

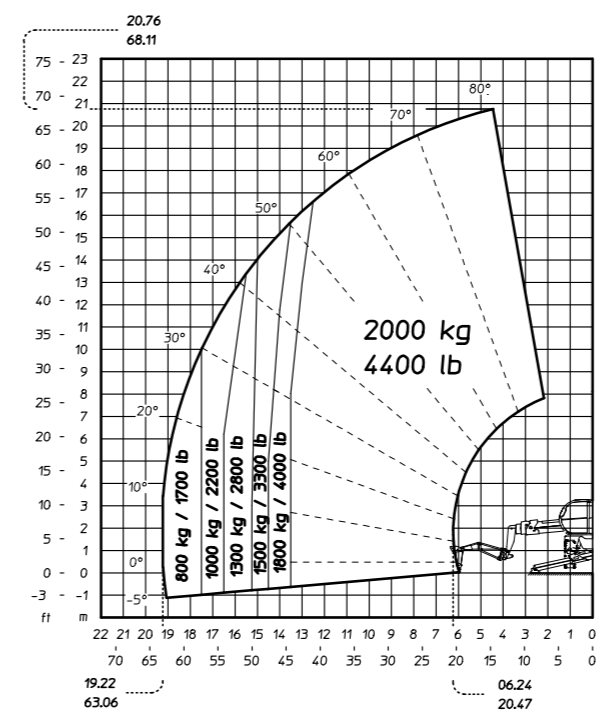

1000kg Platform Load Chart

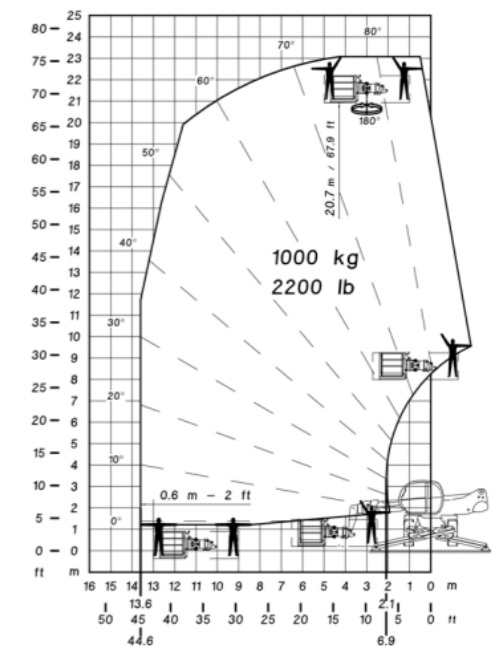

24M ROTO 7T MRT2470



Aircon



Road Legal



Beacons



Chassis Leveling



Adaptive Load Chart



Hose Burst Check Valves



Belly Plate



Bluetooth remote control



E-reco attachment recognition



QR Code Enabled



Slew/Height restrictors



Ardent Insite/site manager



Carbon Offsetting



360 Camera



Reversing Camera



OKO Compatibility

Weight:	21,760 kg
Length:	7,550 mm
Width:	2,490 mm
Height:	3,050 mm
Max Lifting Height:	24,800 mm
Max Lifting Weight:	7,200 kg
Counter Weight Offset:	3.50 m



Width: 6.25m
Length: 5.27m

Rotation on lowered stabilizers
with forks

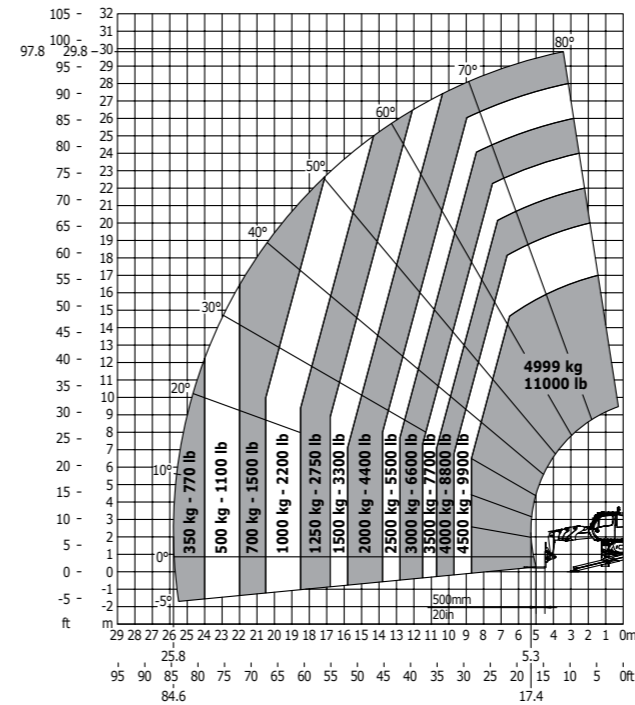

Rotation on lowered stabilizers
with 7200 kg winch

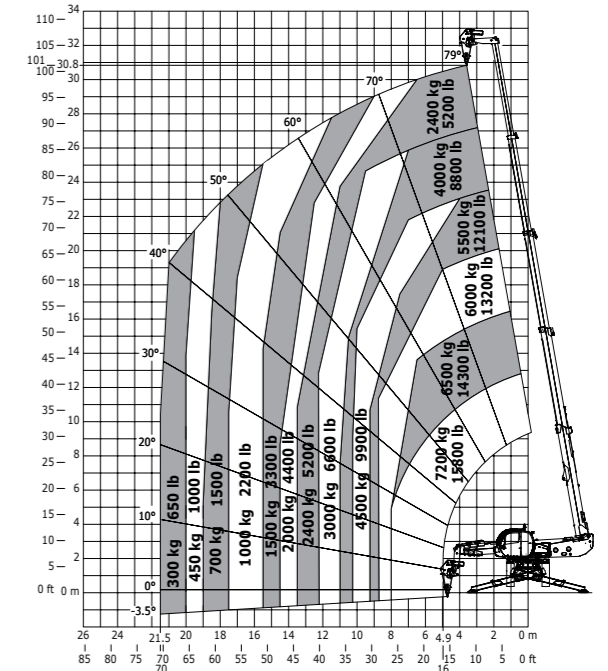

PT2000 Jib Winch Load chart

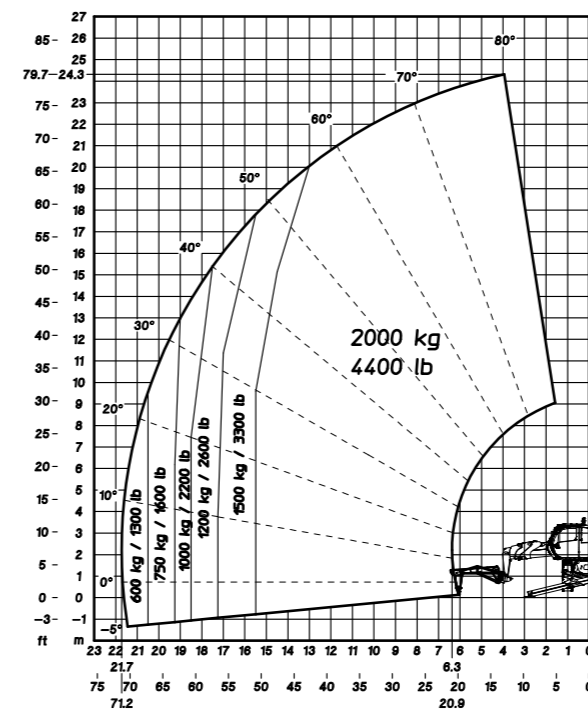

1000kg Platform Load Chart

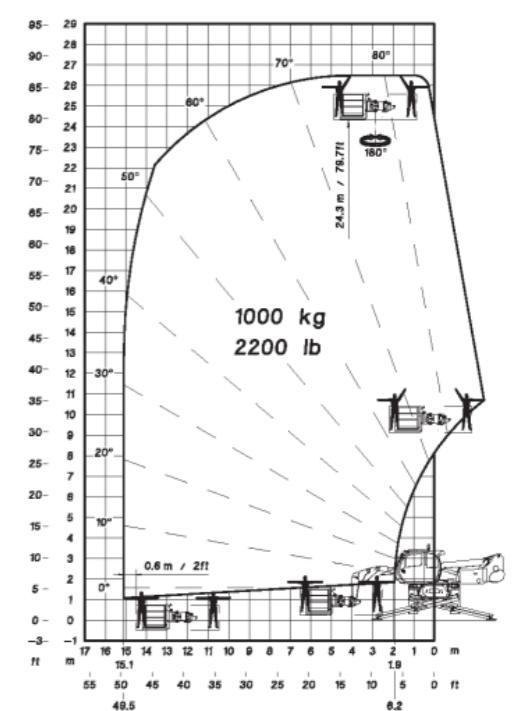

25M ROTO 5T MRT2550



Airon



Road Legal



Beacons



Chassis Leveling



Adaptive Load Chart



Hose Burst Check Valves



Belly Plate



Bluetooth remote control



E-reco attachment recognition



QR Code Enabled



Slew/Height restrictors



Ardent Insite/site manager



Carbon Offsetting



360 Camera



Reversing Camera



OKO Compatibility

Weight:	18,600 kg
Length:	7,830 mm
Width:	2,460 mm
Height:	3,050 mm
Max Lifting Height:	24,600 mm
Max Lifting Weight:	5,000 kg
Counter Weight Offset:	3.18m



Width: 5.55m
Length: 5.19m

Rotation on lowered stabilizers
with forks

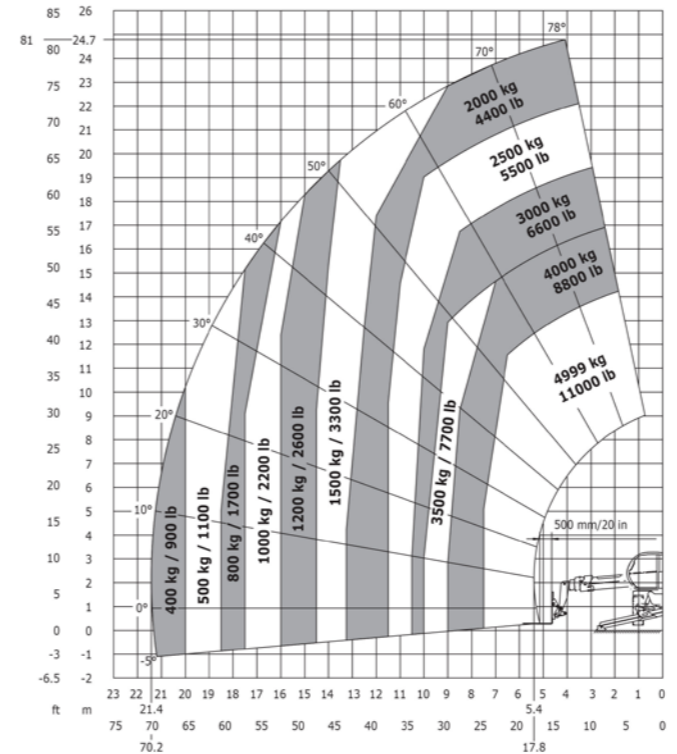

Rotation on lowered stabilizers
with 5000 kg winch

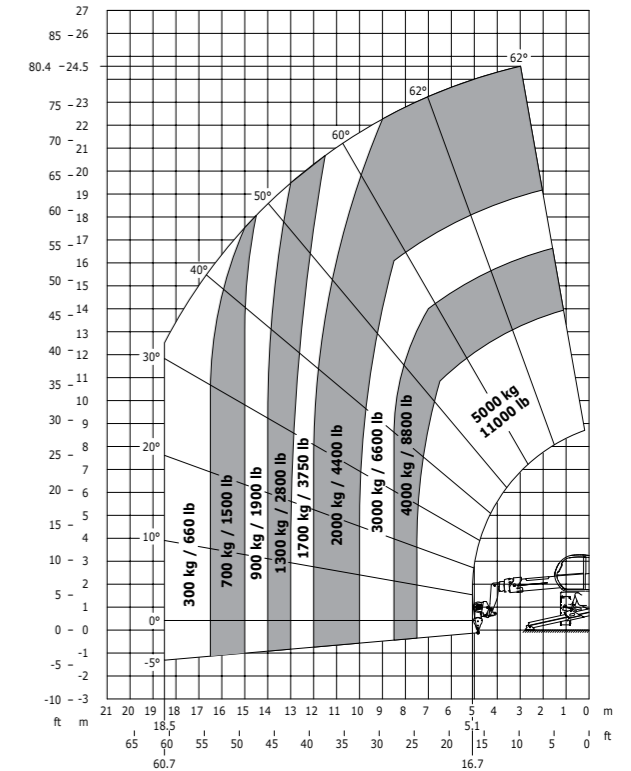

PT2000 Jib Winch Load chart

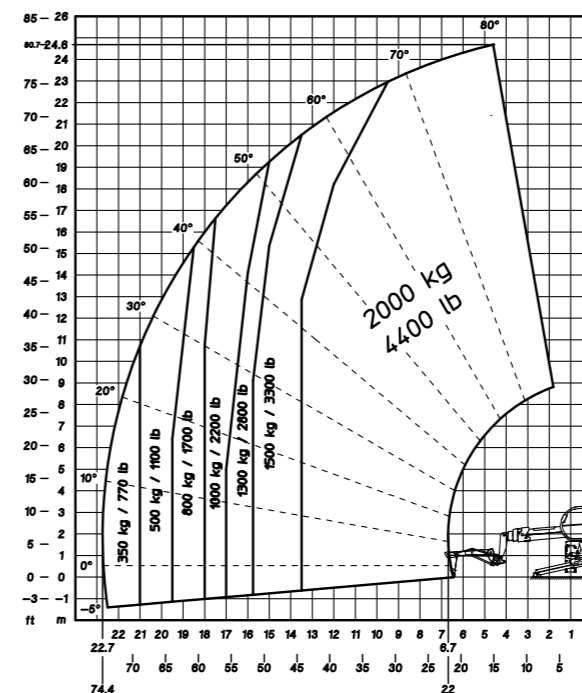

1000kg Platform Load Chart

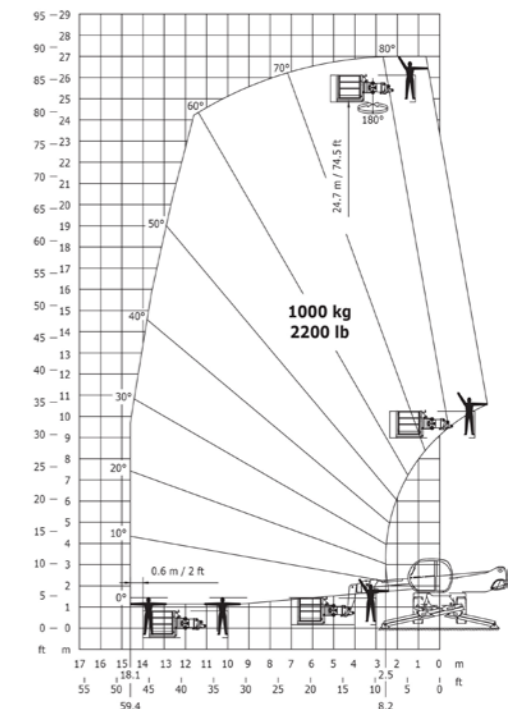

26M ROTO 6T

MRT2660



Aircon



Road Legal



Beacons



Chassis Leveling



Adaptive Load Chart



Hose Burst Check Valves



Belly Plate



Bluetooth remote control



E-reco attachment recognition



QR Code Enabled



Slew/Height restrictors



Ardent Insite/site manager



Carbon Offsetting



Reversing Camera



360 Camera



OKO Compatibility

Weight:	18,000 kg
Length:	9,280 mm
Width:	2,500 mm
Height:	3,100 mm
Max Lifting Height:	25,900 mm
Max Lifting Weight:	6,000 kg
Counter Weight Offset:	3.50 m



Width: 5.78m
Length: 5.30m

Machine on lowered stabilisers
with forks

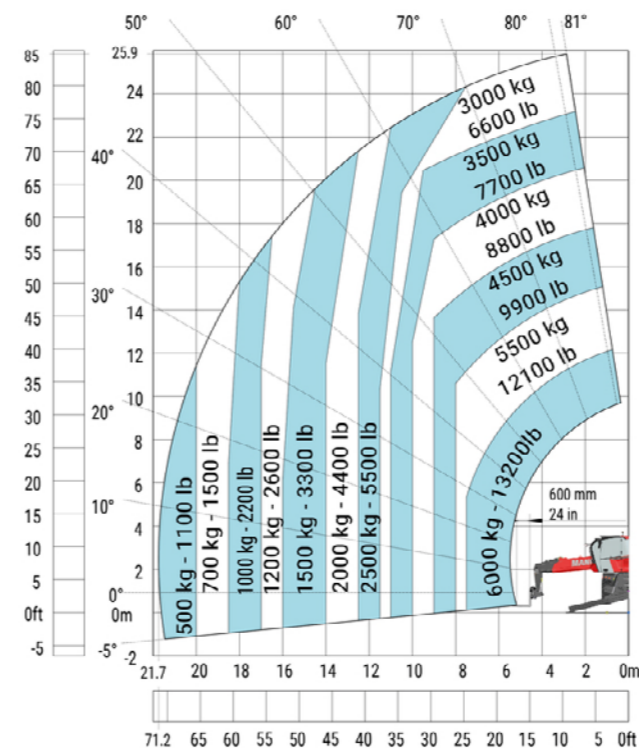

Machine on lowered stabilisers
with 6000 kg winch

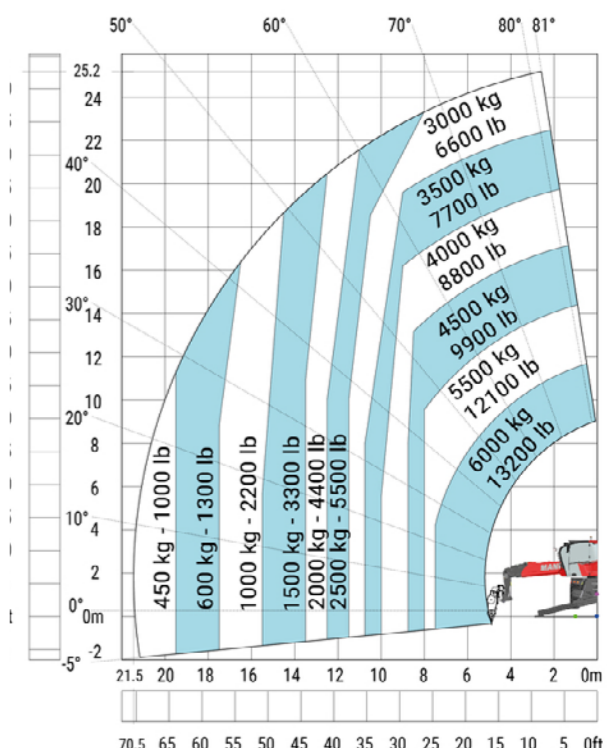

PT2000 Jib Winch chart

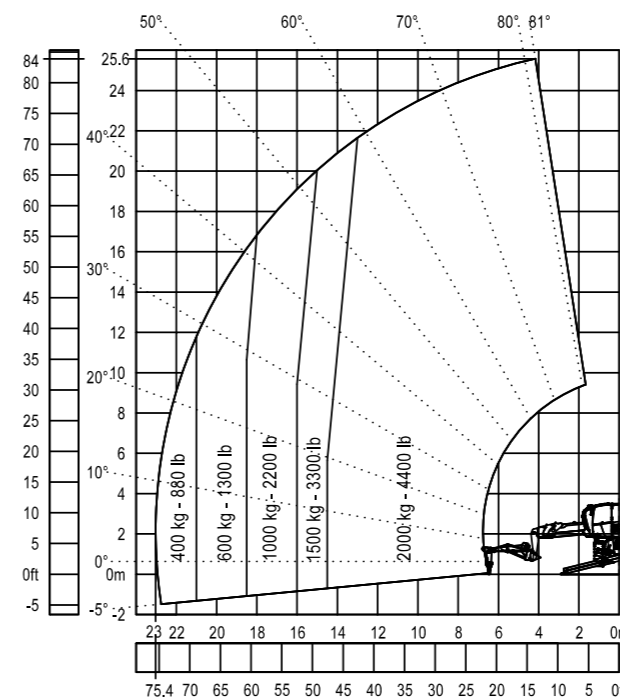

Machine on lowered stabilisers
with 1000 kg platform

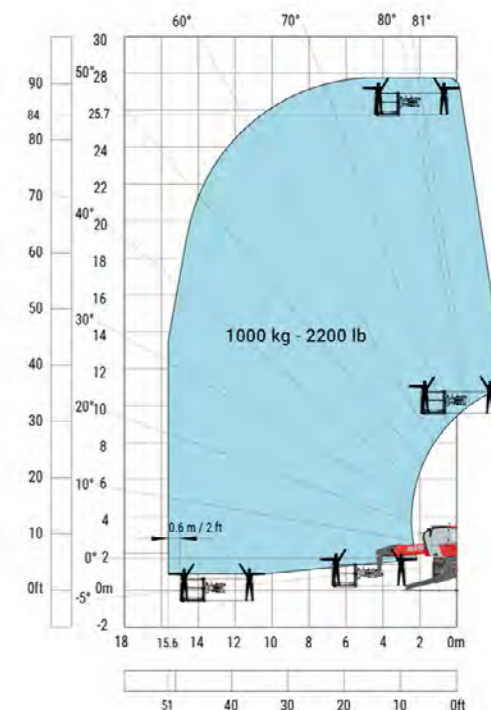

30M ROTO 5T MRT3050



Aircon



Road Legal



Beacons



Chassis Leveling



Adaptive Load Chart



Hose Burst Check Valves



Belly Plate



Bluetooth remote control



E-reco attachment recognition



QR Code Enabled



Slew/Height restrictors



Ardent Insite/site manager



Carbon Offsetting



360 Camera



Reversing Camera



OKO Compatibility

Weight:	22,860 kg
Length:	8,100 mm
Width:	2,500 mm
Height:	3,180 mm
Max Lifting Height:	29,700 mm
Max Lifting Weight:	5,000 kg
Counter Weight Offset:	3.50 m



Width: 6.25m
Length: 5.27m

Rotation on lowered stabilizers
with forks

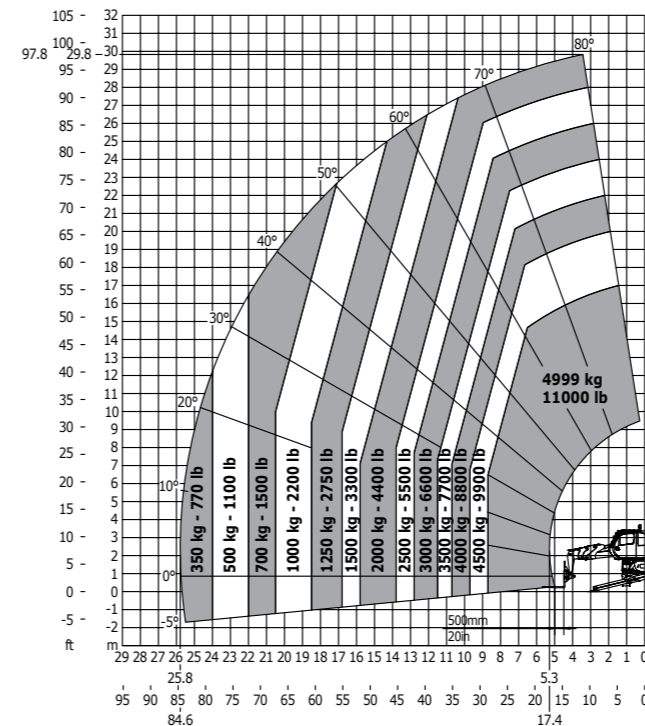

PT2000 Jib Winch Load chart

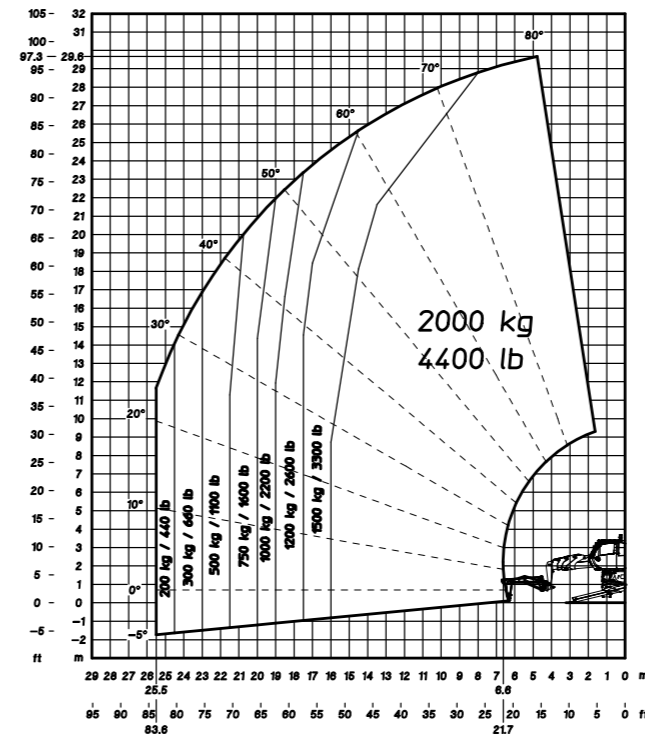

Rotation on lowered stabilizers
with 5000 kg winch

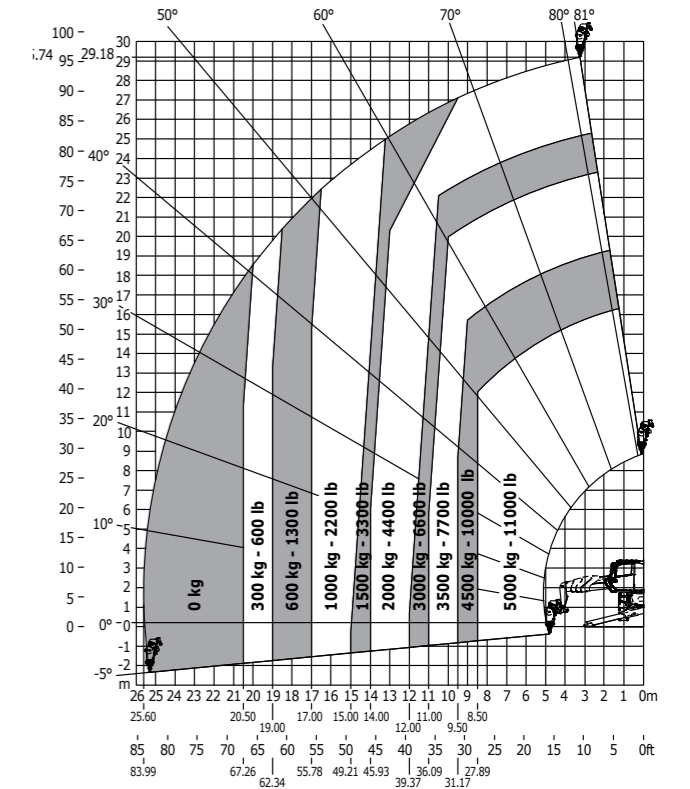

1000kg Platform Load Chart

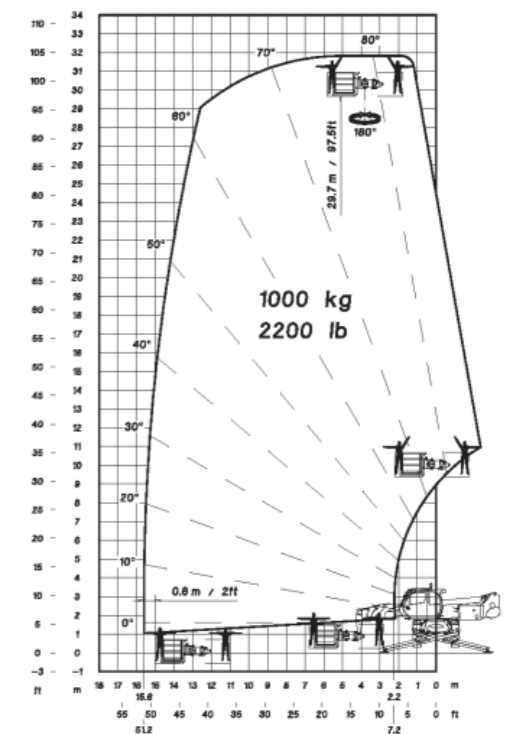

30M ROTO 6T MRT3060



- Aircon
- Road Legal
- Beacons
- Chassis Leveling
- Adaptive Load Chart
- Hose Burst Check Valves
- Belly Plate
- Bluetooth remote control
- E-reco attachment recognition
- QR Code Enabled
- Slew/Height restrictors
- Ardent Insite/site manager
- Carbon Offsetting
- Reversing Camera
- 360 Camera
- OKO Compatibility

Weight:	21,800 kg
Length:	9,140 mm
Width:	2,500 mm
Height:	3,100 mm
Max Lifting Height:	29,900 mm
Max Lifting Weight:	6,000 kg
Counter Weight Offset:	3.45 m



Width: 6.06m
Length: 5.62m

Machine on lowered stabilisers
with forks

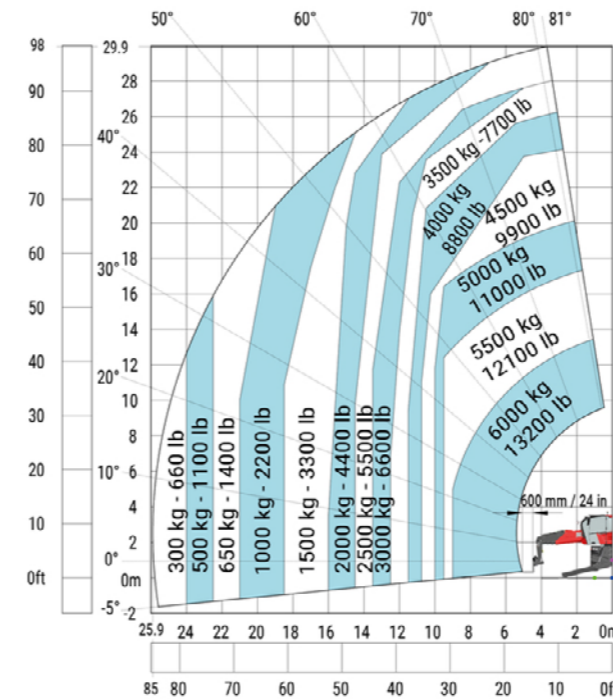

Machine on lowered stabilisers
with 6000 kg winch

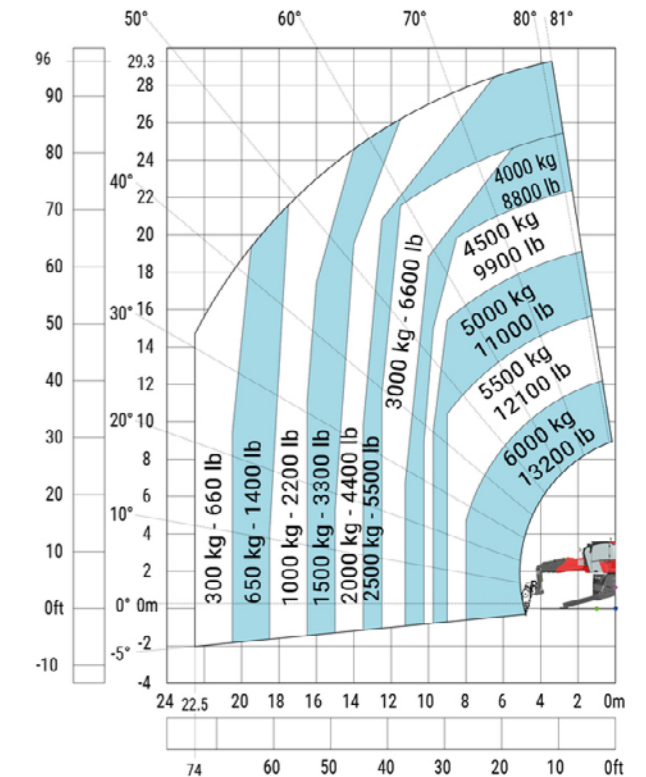

PT2000 Jib Winch chart

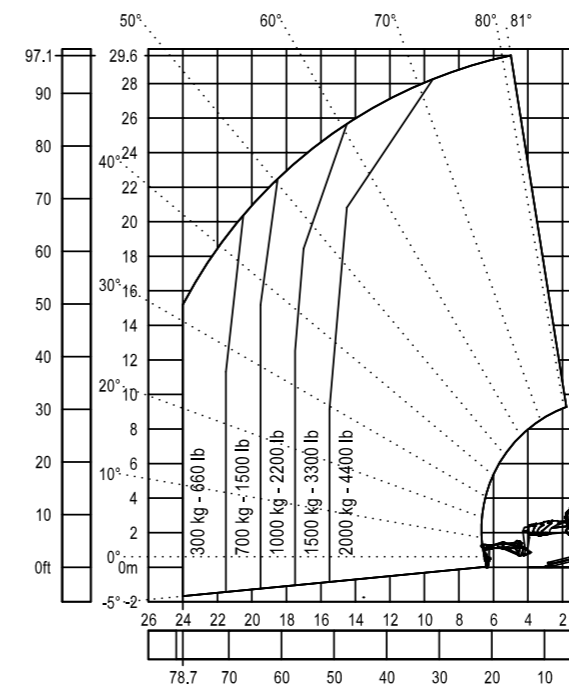

Machine on lowered stabilisers
with 1000 kg platform

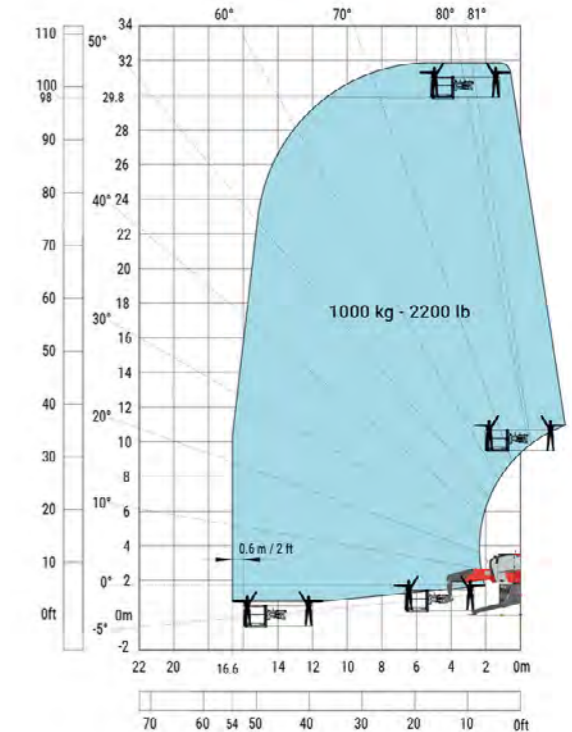

32M ROTO 5.5T MRT3255



Aircon



Road Legal



Beacons



Chassis Leveling



Adaptive Load Chart



Hose Burst Check Valves



Belly Plate



Bluetooth remote control



E-reco attachment recognition



QR Code Enabled



Slew/Height restrictors



Ardent Insite/site manager



Carbon Offsetting



360 Camera



Reversing Camera



OKO Compatibility

Weight:	22,860 kg
Length:	8,100 mm
Width:	2,500 mm
Height:	3,180 mm
Max Lifting Height:	29,700 mm
Max Lifting Weight:	5,500 kg
Counter Weight Offset:	3.80 m



Width: 7.10m
Length: 6.49m

Rotation on lowered stabilizers
with forks

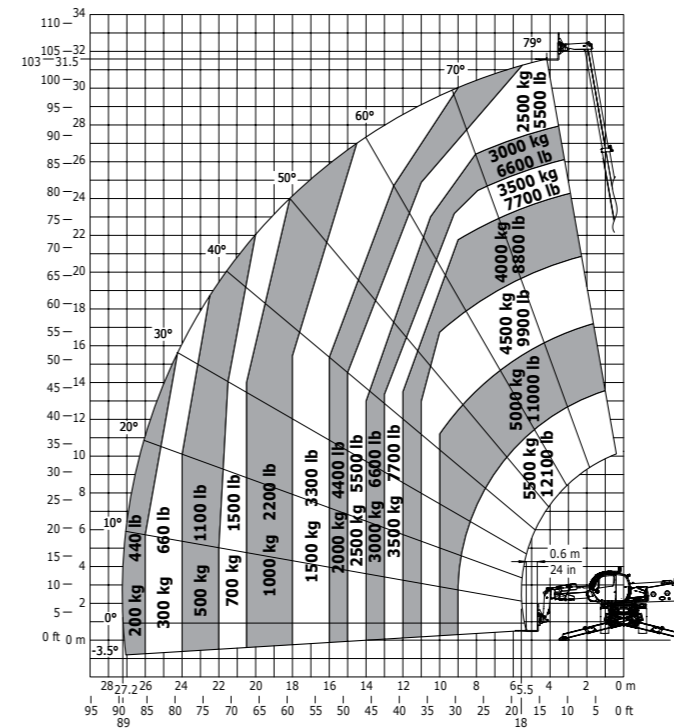

Rotation on lowered stabilizers
with 5500 kg winch

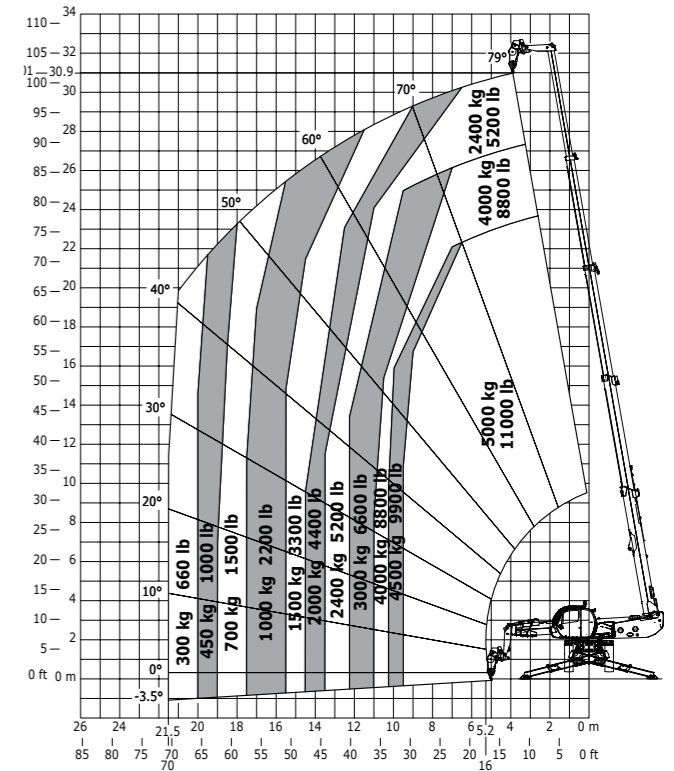

PT2000 Jib Winch Load chart

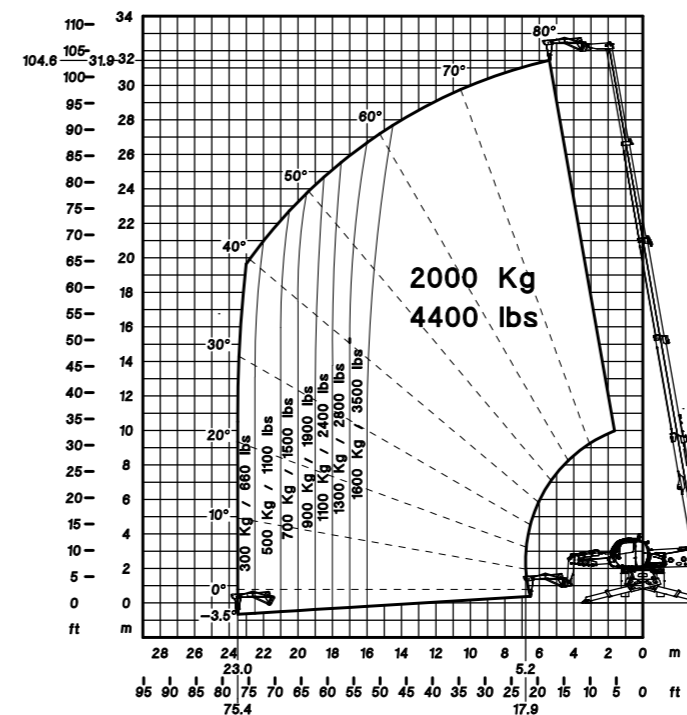

1000kg Platform Load Chart

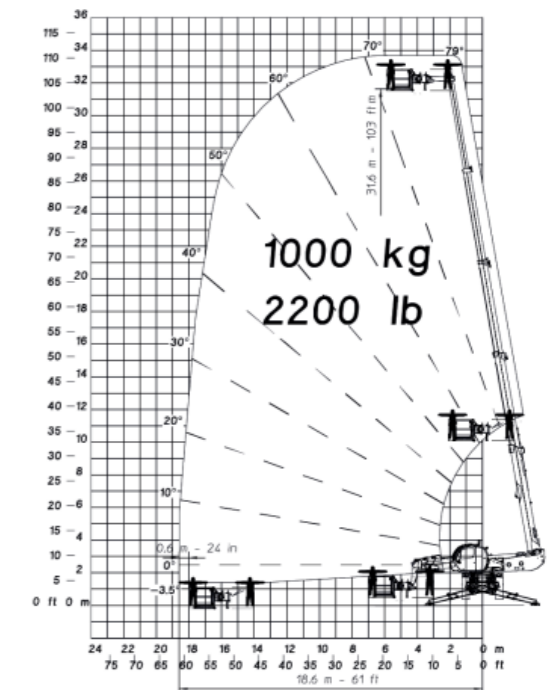

35M ROTO 7T MRT3570



Aircon



Road Legal



Beacons



Chassis Leveling



Adaptive Load Chart



Hose Burst Check Valves



Belly Plate



Bluetooth remote control



E-reco attachment recognition



QR Code Enabled



Slew/Height restrictors



Ardent Insite/site manager



Carbon Offsetting



Reversing Camera



360 Camera



OKO Compatibility

Weight:	23,800 kg
Length:	10,060 mm
Width:	2,500 mm
Height:	3,260 mm
Max Lifting Height:	34.700 mm
Max Lifting Weight:	7,000 kg
Counter Weight Offset:	3,74 m



Width: 7.4m
Length: 6.49m

Machine on lowered stabilizers
with forks

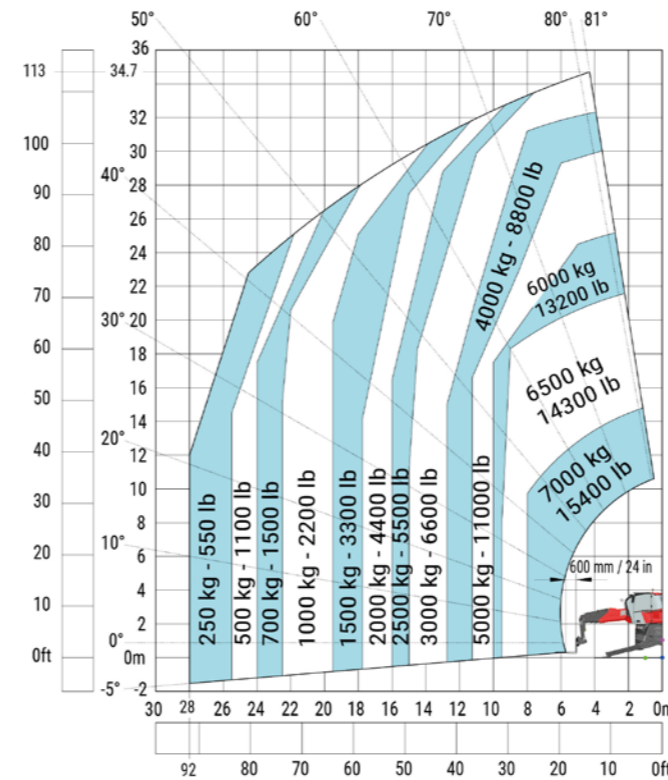

Machine on lowered stabilizers
with winch 7200kg

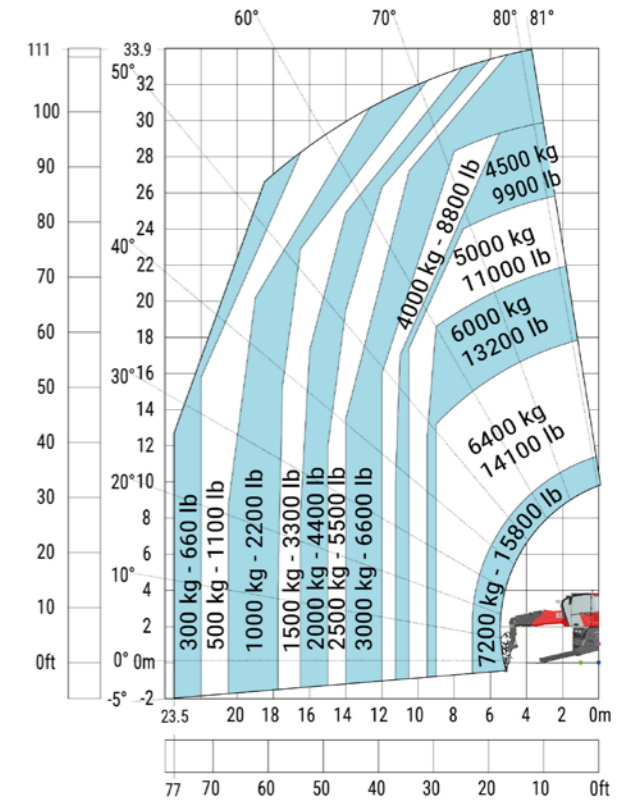

PT2000 Jib Winch chart

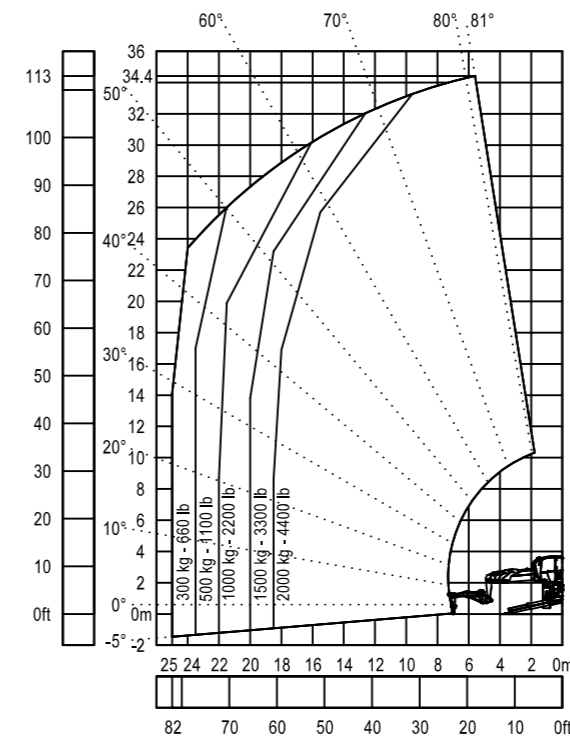

Machine on lowered stabilizers
with 1000 kg Platform

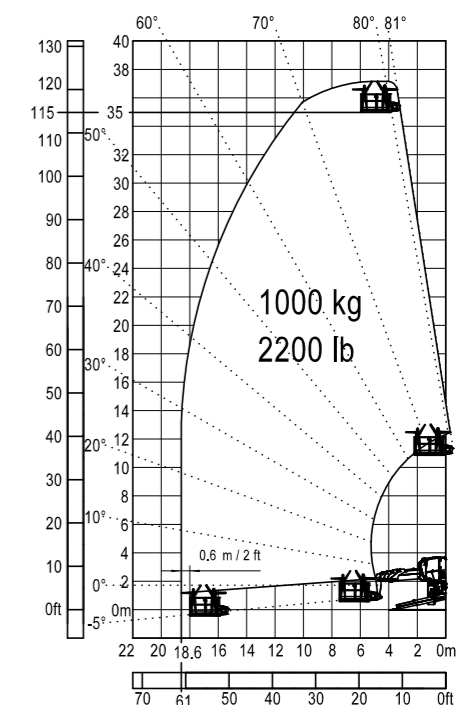

KEY BENEFITS

All the capabilities of small cranes with the versatility of a tele handler

- Quick set up time
- Heavy lifting capabilities – up to 7t
- Long boom length – 21m to 35m
- Adaptive telescopic stabilisers
- Remote controlled – if required
- Compact and versatile machine
- Wide range of attachments available – forks, 360 forks, winch, jib extension, man basket,
- E-reco automatic attachment recognition
- Adaptive load chart
- All terrain and all wheel steer
- 360 continuous slew
- Slew and height restrictions
- Pentagonal boom
- Coloured operations display panel
- Easy direct access to the cab
- Excellent visibility from within the cab
- Spacious comfortable cab
- High specification on our machines as standard
- Large fleet size, Privilege plus range and New Vision plus range
- Nationwide coverage for fitters
- Site survey
- Self-drive or operated plant by our experienced operators
- Ardent Familiarisation training
- Ardent Insite, site manager etc.
- Carbon offsetting
- Outrigger mats available on request (600mm X 600mm or 1000mm X 1000mm)



ATTACHMENTS

A complete range of tools adapted to the construction world Manitou telehandlers are effective tool carriers where you can easily attach the specific attachment required. To cater to your needs and activities, we recommend a range of Manitou-approved attachments fully compatible with our machines.

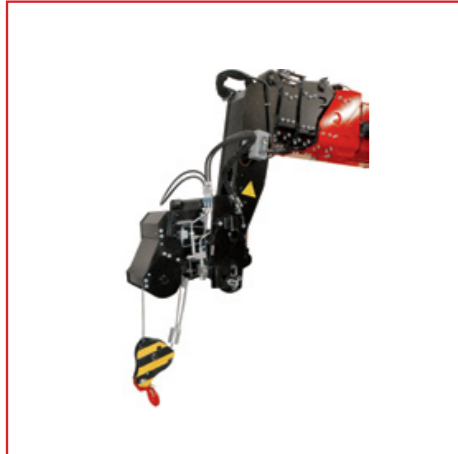

HYDRAULIC BOX WINCH

- Oil immersed negative brake for low running costs.
- Double line pull winch for an ideal compromise between pulling effort & speed
- Standard cable guide for easy operations.
- Safety: homologated self-locking swivel hook
- Storage stand preventing any contact between the winch & the ground, as well as ensuring a permanent cable tension



PT2000 JIB WITH WINCH

- Perfect for transporting and placing beams, frames.
- Improves the forward reach of the telehandler.



360° ROTATING FORK CARRIAGE

- Major increase of your MRT's functionality that's to a continuous 360° fork rotation.
- 2 capacities: 4000kg frontal (+/- 15°) and 2500kg rotated.
- Safety: constant monitoring of the load's weight, angle & position; adaptive overload control according to the load's position; no forward tilting if rotation > 120° and boom lifted over 3m high.
- Lower fuel consumption: limits machine movements & manoeuvres



FAST OPENING PSE 4400M PLATFORM

- Maximum safety & efficiency in people lifting.
- Folding/unfolding within 50 seconds.
- Legally approved for 3 people.
- All platforms with 3 accesses (2x side + in front).
- Overload sensor
- Non-slip metal floor
- 1000kg capacity including up to 3 people
- Working width from 2.25m up to 4.4m
- +/- 90° Slew

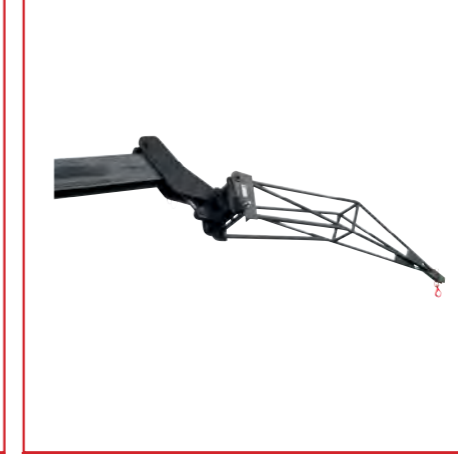

P2000 JIB

- Perfect for transporting and placing beams, frames.
- Improves the forward reach of the telehandler.



PC50 HOOK

- Very compact attachment keeping the machine's capacity & stability unchanged.
- Safety: homologated self-locking swivel hook.
- Basic attachment for safe suspended load handling.



ROTO AND BOX WINCH



BOX WINCH ON STORAGE STAND



MAN BASKET PLATFORM FITS ALL SIZE MACHINES



ROTO OPERATED VIA BLUETOOTH REMOTE

NATIONWIDE COVERAGE

**Ardent has a depot near you,
with a nationwide depot network**

Covering the whole of the UK.

We're expanding our network all the time, so that you can access the equipment you need where you need it, fast.

We already have 11 depots across the country stretching across Scotland to Southampton, to make our fleet as accessible and as convenient as possible.

Head Office / Accounts

Ardent House,
32 Crown Road, Enfield,
Middlesex, EN1 1TH

0208 443 7100

Hire Desk / Customer Service

Felixstowe Road,
Ipswich,
Suffolk, IP3 9BS

National Hire Number
03333 202 555

Key Contact

Technical Support & Site Surveys

✉ roto@ardenthire.com

For New & Existing Hires

☎ 03333 202 555 (opt.1)

✉ hire@ardenthire.com

For Field Service or Support

☎ 03333 202 555 (opt.2)

✉ customerservice@ardenthire.com

For Damage Queries

☎ 03333 202 555 (opt.3)

✉ notifications@ardenthire.com

Digital

☎ 03333 202 555 (opt.4)

✉ digital@ardenthire.com

For Invoice Queries

☎ 03333 202 555 (opt.5)

✉ creditcontrol@ardenthire.com





Head Office:

Ardent House, 32 Crown Road, Enfield, Middlesex, EN1 1TH

03333 202 555

roto@ardenthire.com

www.ardenthire.com